

NOTES:

TOP:
 - 19 MM CHERRY PART BOARD
 - 20 X 20 SOLID EDGING, MITRED CORNERS

FRAME:
 - CHERRY SOLIDS AND SHEET GOODS
 - BACK PANEL SUPPLIED TO SIZE

DRAWER JOINERY:
 - HANDCUT DOVETAILED, MARKED BEFORE AND AFTER ASSEMBLY

PROJECT:

ARTS & CRAFTS TABLE

LEVEL:

Drawing Description

DATE:

02/28/2024

SCALE:

AS SHOWN

DRAWN BY:

TB/HB

SHEET:

1 OF 4

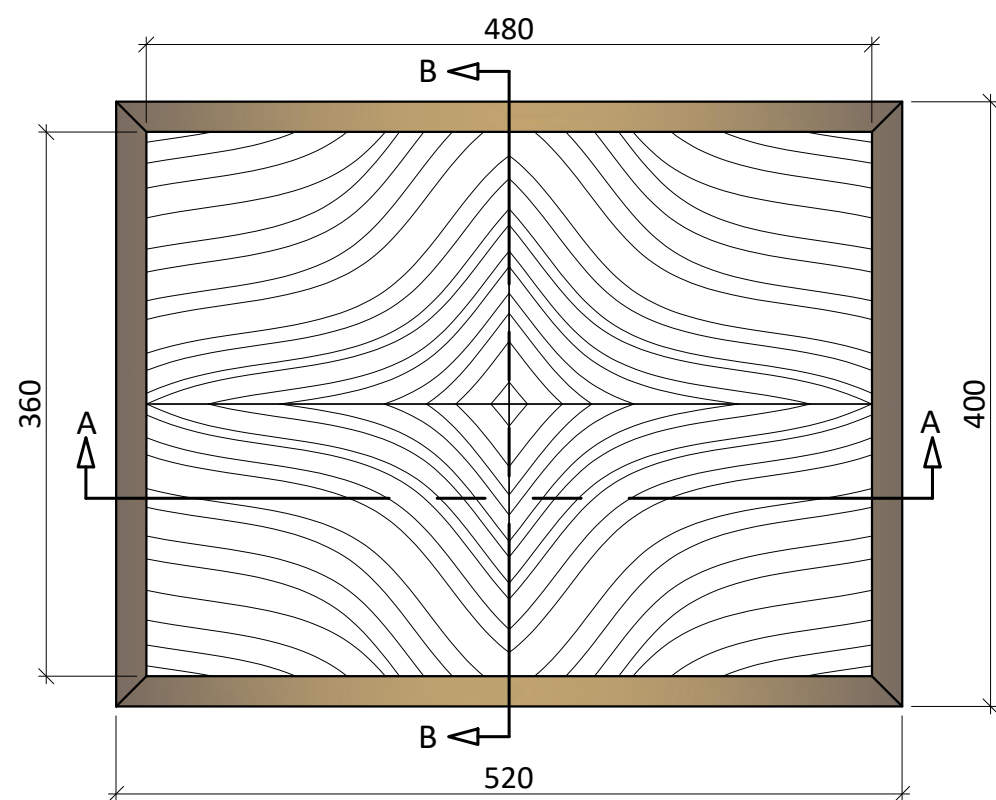

DOVETAIL SLOPE 1 : 6

SECONDARY TO RABBET ALL CORNERS OF DRAWER BOX

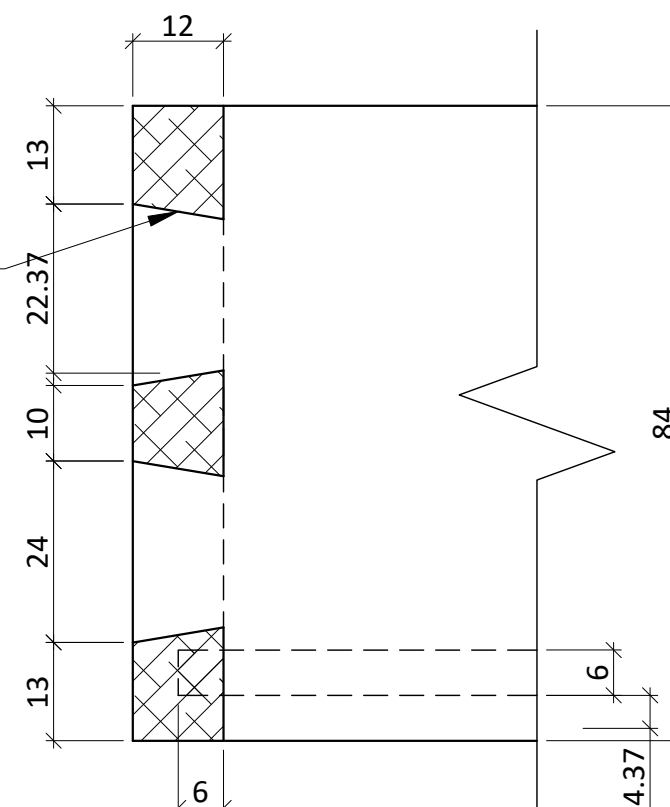

POST SECONDARY
 DRAWER CORNER JOINERY SCALE 1 : 1
 DOVE TAIL FRONT ONLY & RABBET BACK

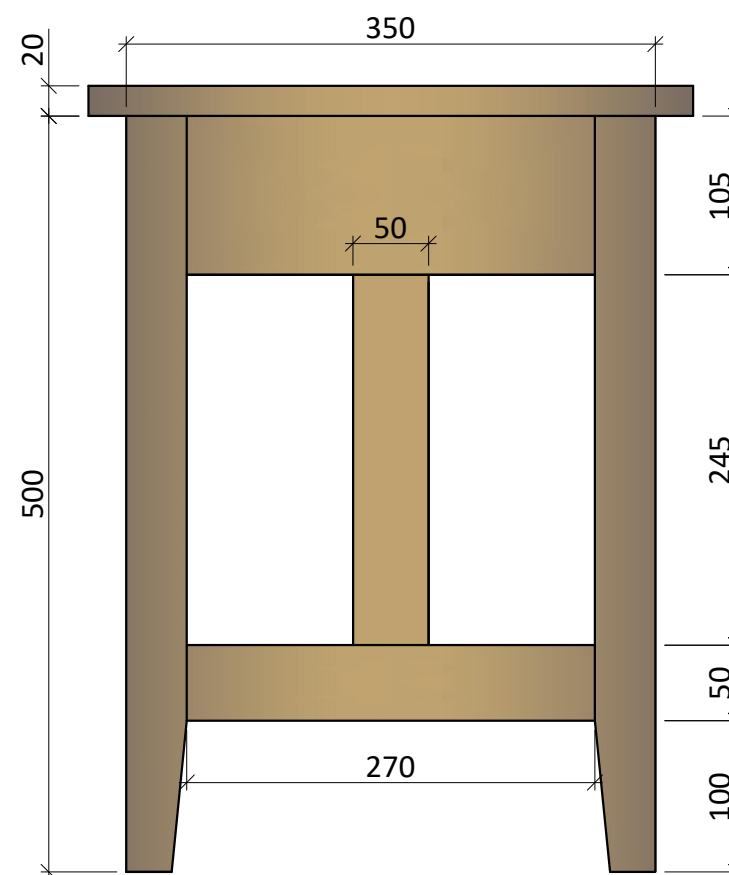
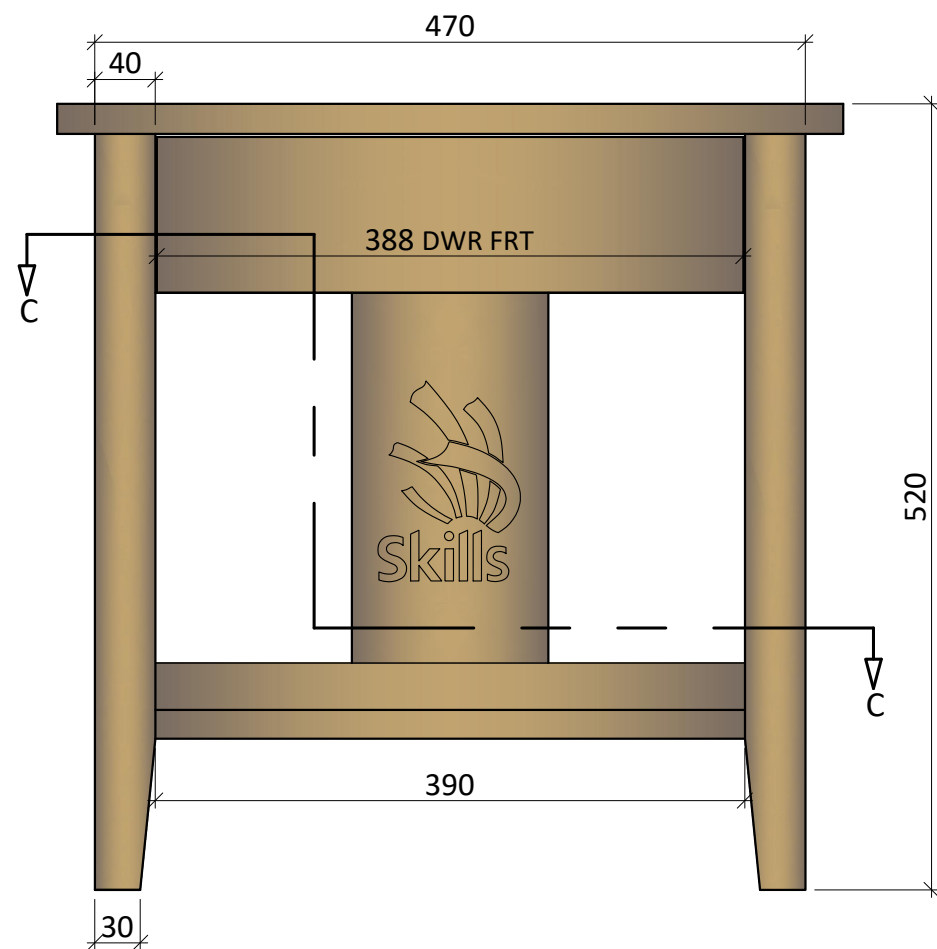

TOP, FRONT AND RS ORTHOGRAPHIC VIEWS SCALE 1 : 5

NOTE:
 DRAWINGS FOR TRAINING PURPOSES ONLY
 COMPETITION PROJECT MAY HAVE UP TO 30% CHANGE

NOTE:
DRAWINGS FOR TRAINING PURPOSES ONLY
COMPETITION PROJECT MAY HAVE UP TO 30% CHANGE

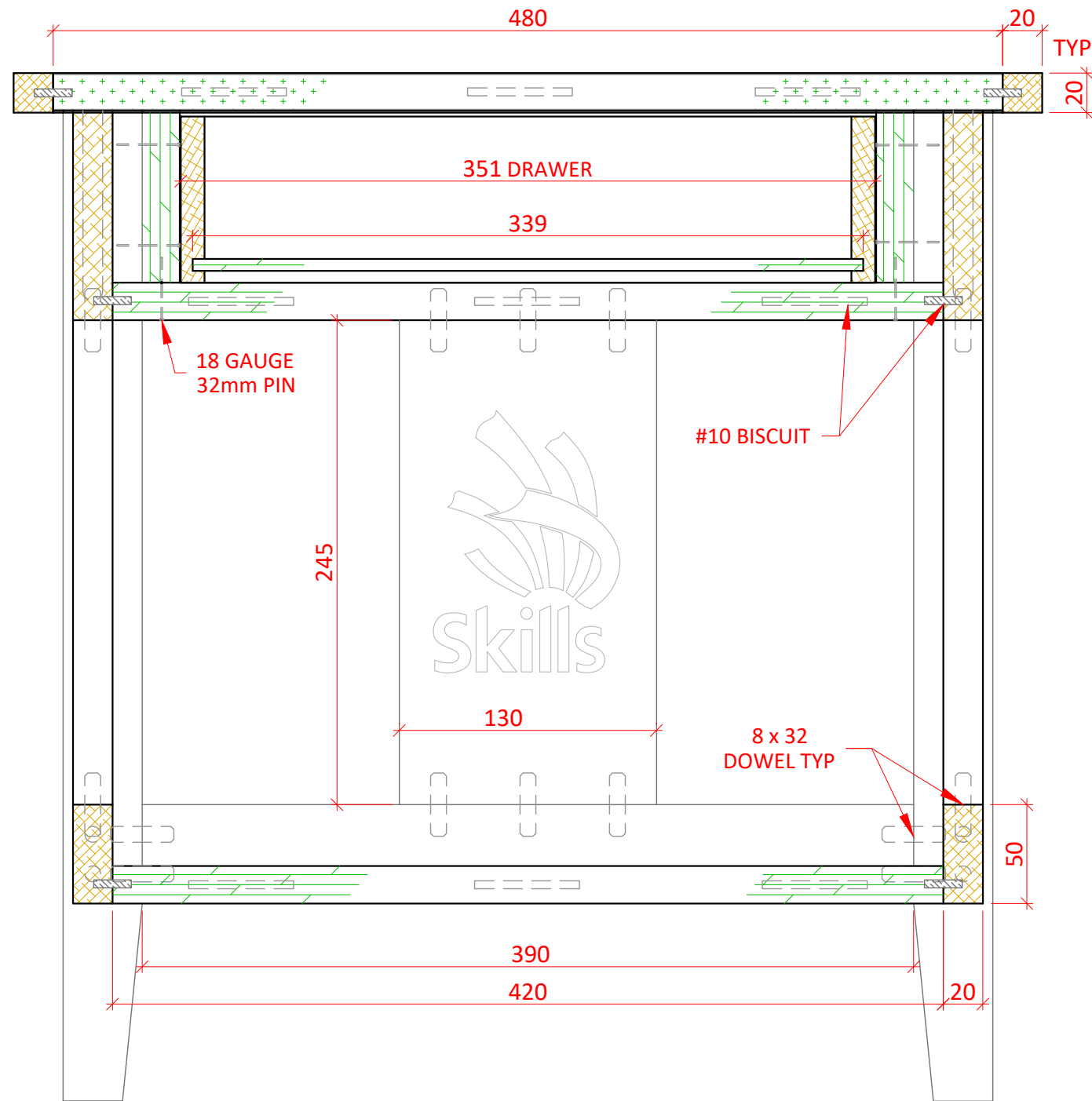

SECTION A : A SCALE 1 : 3

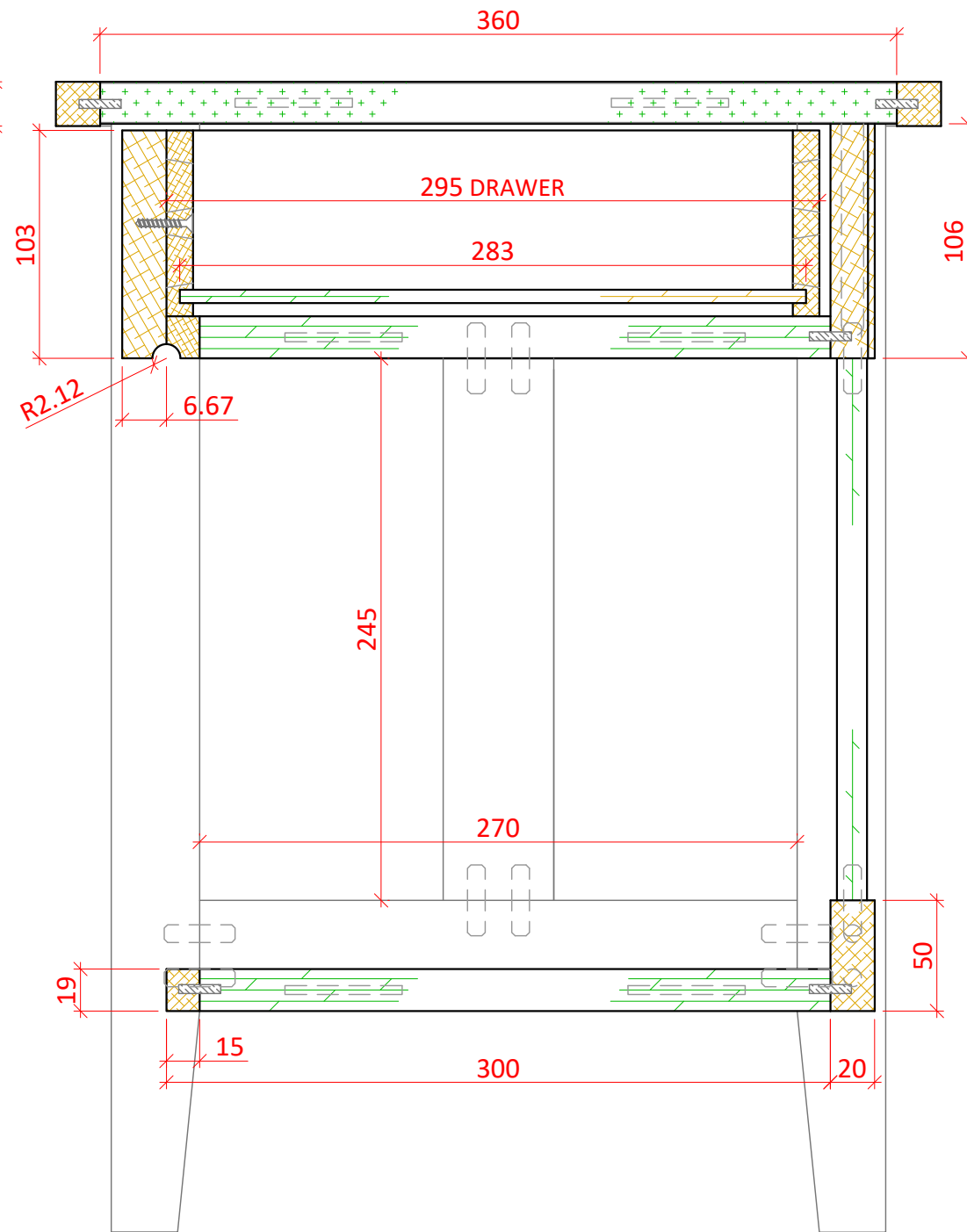

SECTION B : B SCALE 1 : 3

NOTES:

- TOP:
- 19 MM CHERRY PART BOARD
- 20 x 20 SOLID EDGING, MITRED CORNERS
- FRAME:
- CHERRY SOLIDS AND SHEET GOODS
- BACK PANEL SUPPLIED TO SIZE
- DRAWER JOINERY:
- HANDCUT DOVETAILES, MARKED BEFORE AND AFTER ASSEMBLY

PROJECT:

ARTS & CRAFTS TABLE

LEVEL:

Drawing Description

DATE:

02/28/2024

SCALE:

AS SHOWN

DRAWN BY:

TB/HB

SHEET:

2 OF 4

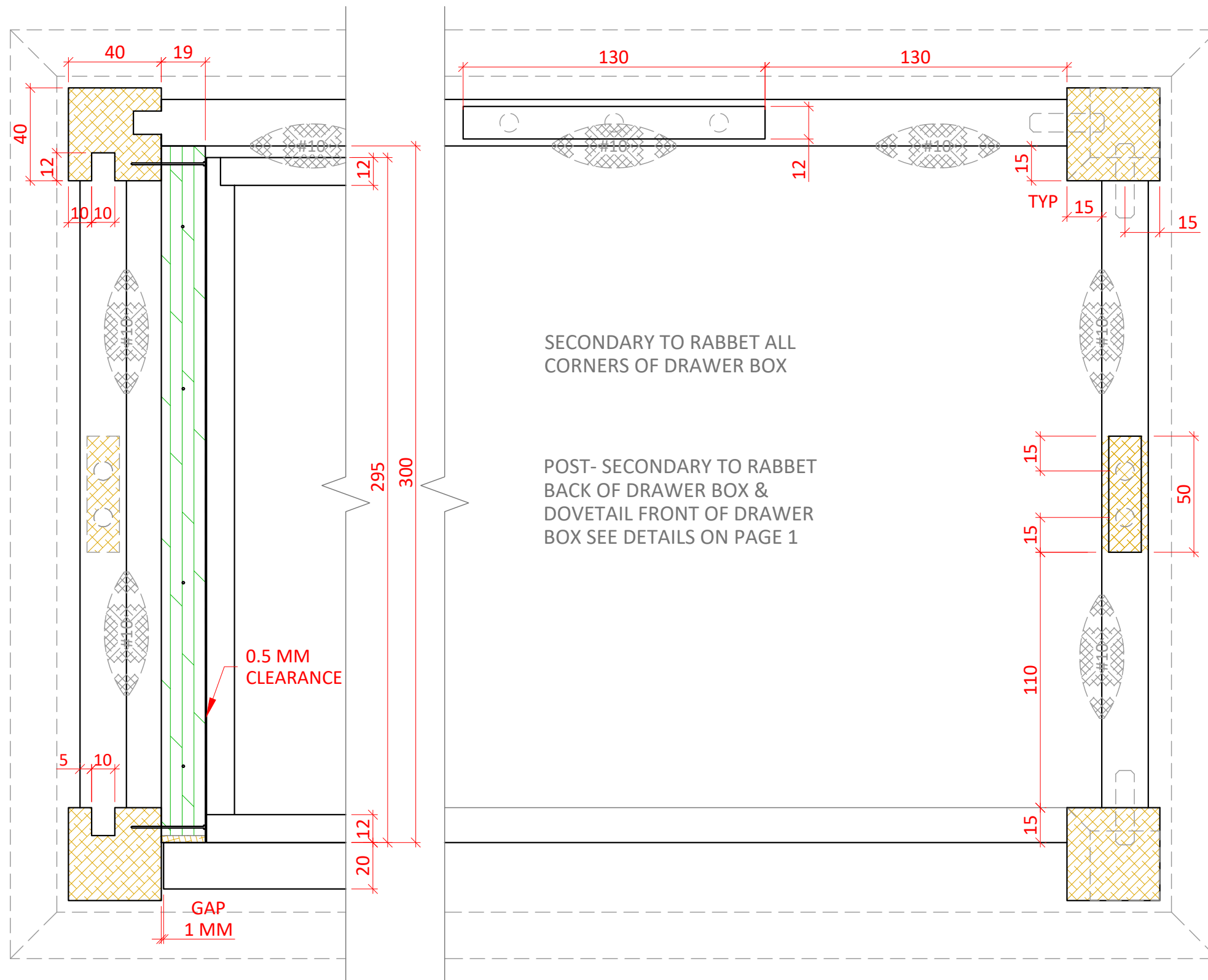

NOTES:

TOP:
- 19 MM CHERRY PART BOARD
- 20 X 20 SOLID EDGING, MITRED CORNERS

FRAME:
- CHERRY SOLIDS AND SHEET GOODS
- BACK PANEL SUPPLIED TO SIZE

DRAWER JOINERY:
- HANDCUT DOVETAILS, MARKED BEFORE AND AFTER ASSEMBLY

PROJECT:

ARTS & CRAFTS TABLE

LEVEL:

Drawing Description

DATE:

02/28/2024

SCALE:

AS SHOWN

DRAWN BY:

TB/HB

SHEET:

3 OF 4

NOTE:
DRAWINGS FOR TRAINING PURPOSES ONLY
COMPETITION PROJECT MAY HAVE UP TO 30% CHANGE

NOTE:
 DRAWINGS FOR TRAINING PURPOSES ONLY
 COMPETITION PROJECT MAY HAVE UP TO 30% CHANGE

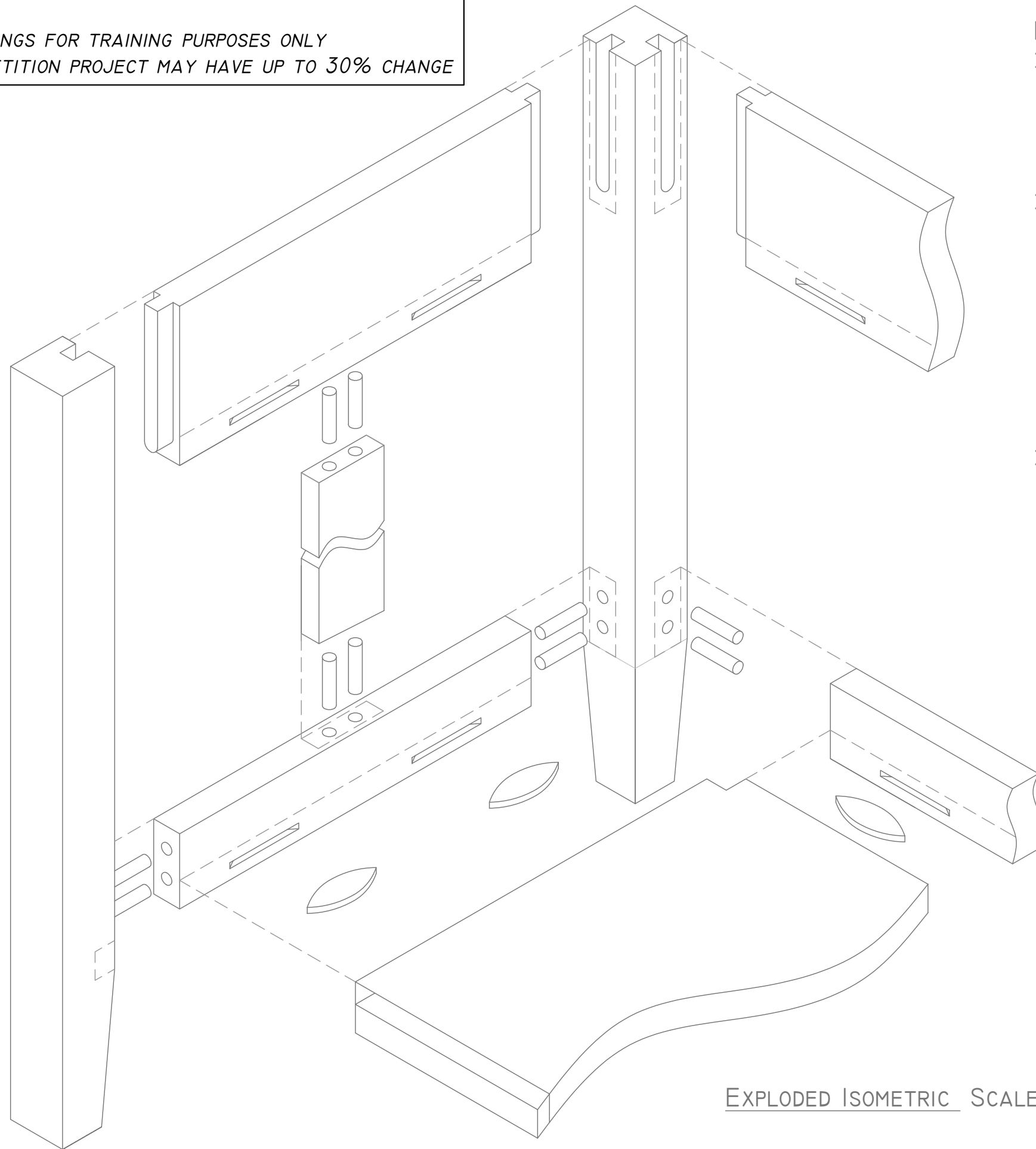

PROCESS CHECKLIST:

- > LEGS -
 - SLOT MORTISES FOR TOP RAILS
 - 8MM HOLES FOR LOWER RAIL DOWELS
 - TAPER INSIDE FACES, 100 UP FROM BTM
- > TOP RAILS -
 - TENONS SHAPED TO FIT MORTISES (OR MORTISES SQUARED TO FIT TENONS)
 - BISCUITS CUT FOR MID SHELF
 - HOLES FOR MULLION DOWELS (SIDE RAILS ONLY)
 - STOP GROOVE FOR BACK PANEL (NOT SHOWN, BACK RAIL ONLY)
- > LOWER RAILS -
 - HOLES FOR DOWELS TO LEGS
 - HOLES FOR DOWELS TO MULLION (SIDE RAILS ONLY)
 - BISCUITS FOR LOWER SHELF

NOTES:

- TOP:
- 19 MM CHERRY PART BOARD
 - 20 x 20 SOLID EDGING, MITRED CORNERS
- FRAME:
- CHERRY SOLIDS AND SHEET GOODS
 - BACK PANEL SUPPLIED TO SIZE
- DRAWER JOINERY:
- HANDCUT DOVETAILS, MARKED BEFORE AND AFTER ASSEMBLY

PROJECT:

ARTS & CRAFTS TABLE

LEVEL:

Drawing Description

DATE:

02/28/2024

SCALE:

AS SHOWN

DRAWN BY:

TB/HB

SHEET:

4 OF 4

EXPLODED ISOMETRIC SCALE 1 : 3